

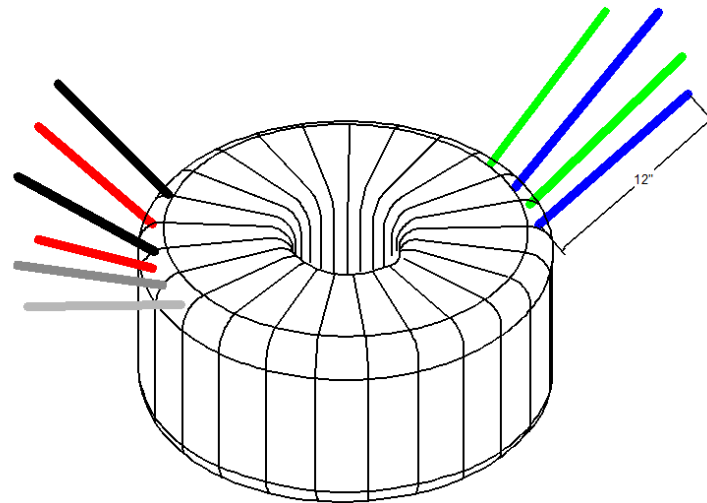

The 25VA industrial toroidal power transformer has higher efficiency than EI transformers, typically around 95 to 99%. Because of the effective containment of the magnetic flux inside the core, toroidal transformer will have a lot less interference with adjacent components. It has very lower mechanical humming and lower heat generated.

These AU series transformers are specially designed to work on all standard 115V, 230V and 277V at 50Hz or 60Hz. These transformers have heavier gauge wires than the normal requirement to avoid the copper lost during the full power output. The dielectric leakage current test is up to 3500Vac in between primary and secondary coils.

This transformer comes with 2 rubber pads, holding disk and center bolt assembly.

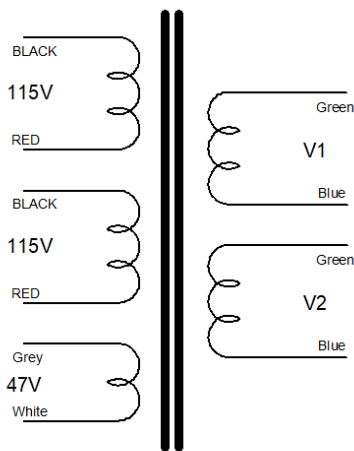

D=2.9"
H=1.6"

Weight=1 LB
IEC EN61558
UL E497714

Open Circuit Test (core loss test): TEST CONDITION: Apply variable voltage to primary coils (in parallel). Set voltages 120 and 140VAC at 60Hz. No load on secondary coils. Measure the primary current and input power.	V _{voltage input}	C _{Current input}	P _{Power lost}
	120V 140V	.01A .01A	0.6W 0.8W
Short Circuit Test (copper loss test): TEST CONDITION: Short all secondary coils, and apply variable voltage to (parallel) primary coils. Varies the voltage from 0-20VAC at 60Hz and freeze the voltage at rated primary current.	V _{voltage input}	C _{Current rated}	P _{Power lost}
	9.2V	0.2A	1.8W
Load Test (operation test): TEST CONDITION: Input 120VAC 60Hz to the primary coils (in parallel), Output 1 and 2 in parallel to load, and measure voltage and current at different load levels.	V _{voltage output}	C _{Current output}	P _{Power output}
	19.0V	0.0A	0W
	18.0V	0.9A	16W
	17.1V	1.7A	29W
DC Resistant Test: DC OHM METER: Test primary and secondary coils (value for each coil).	Primary		Secondary
	39 ohm		1.2 ohm